

# BRIZO®

## VALVE W/ INTEGRATED DIVERTER TRIM

- Litze® Bath Collections
- MultiChoice® Valve Trim with Three Function Diverter (T75P535-LHP)
- MultiChoice® Valve Trim with Six Function Diverter (T75P635-LHP)

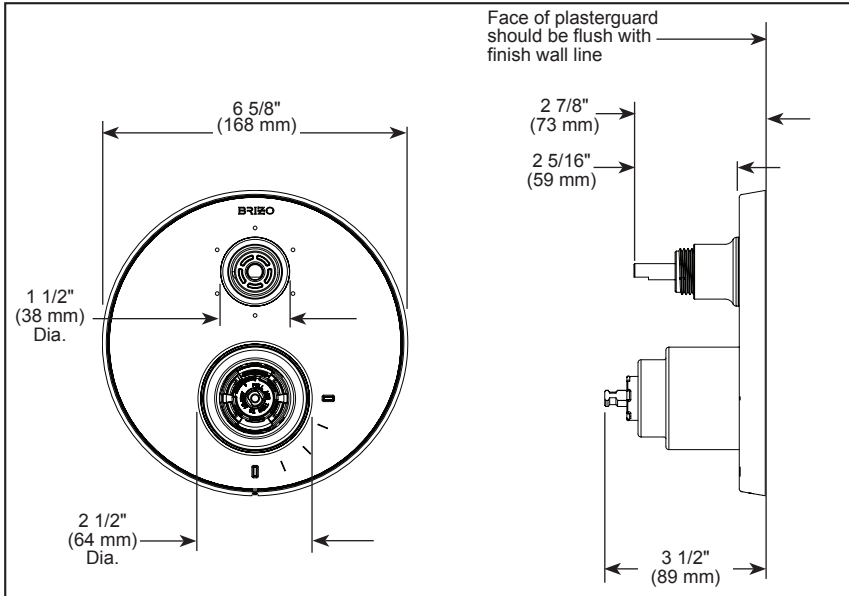
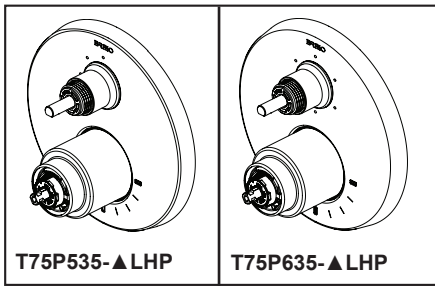

### FEATURES:

- Pressure balance valve cartridge
- Three or six function diverter

### STANDARD SPECIFICATIONS:

- Maintains a balanced pressure of hot and cold water even when a valve is turned on or off elsewhere in the system
- Back-to-back installation capability
- For use with MultiChoice® Universal Integrated Shower Diverter Rough (R75000 Series)
- Max. system flow rate 7.2 gpm at 60 psi with R75000
- Top handle controls diverter functions
- Bottom handle controls on/off and temperature
- Field adjustable to limit handle rotation into hot water zone
- Bottom handle 120° maximum rotation
- Red/Blue temperature indicator markings
- Three function diverter (T75P535-▲LHP) has 2 individual positions and 1 shared position
- For two individual functions, no shared functions, order additional RP72123
- Six function diverter (T75P635-▲LHP) has 3 individual positions and 3 shared positions
- For three individual functions, no shared functions, order additional RP72124
- 1/2" rough-in
- Cartridges included
- Standard installation allows up to 1 1/8" finished wall thickness
- Thick wall installation kit RP100160▲ can be ordered to allow for up to 2 1/8" finished wall thickness
- Handles sold separately

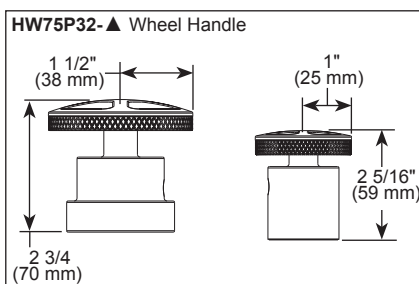
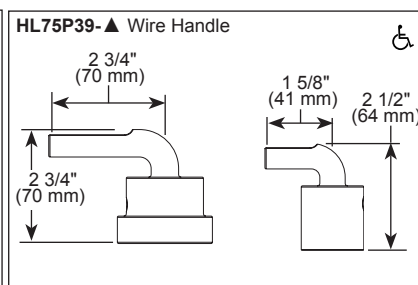
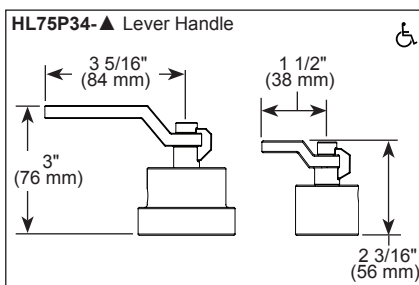
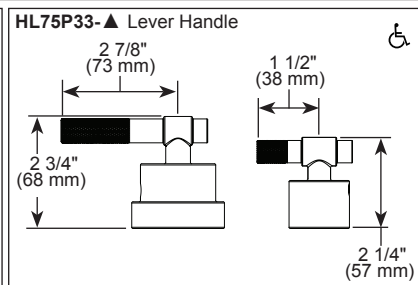
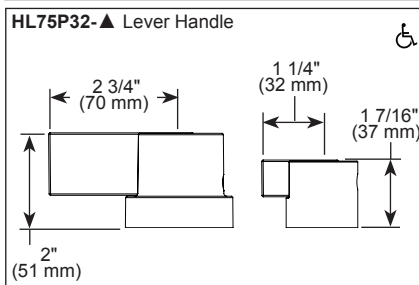

▲ Designate Proper Finish Suffix

### WARRANTY

- Parts and Finish - Lifetime limited warranty; or for commercial purchasers, 10 years for multi-family residential (apartments and condominiums) and 5 years for all other commercial uses, in each case from the date the product is received by the original purchaser or their authorized representative (installation contractor, etc.).
- Please go to [www.brizo.com](http://www.brizo.com) for the complete details of our limited warranty.

### COMPLIES WITH:

- ASME A112.18.1 / CSA B125.1
- ASSE 1016 / ASME A112.1016 / CSA B125.16
- ICC/ANSI A117.1

Brizo Kitchen & Bath Company reserves the right (1) to make changes in specifications and materials, and (2) to change or discontinue models, both without notice or obligation. Dimensions are for reference only. See current full-line price book or [www.brizo.com](http://www.brizo.com) for finish options and product availability.

BSP-B-T75P535-LHP Rev. C

### Brizo Kitchen & Bath Faucet Company

55 E. 111th Street, Carmel, IN 46280  
 350 South Edgeware Road, St. Thomas, ON N5P 4L1  
 © 2025 Brizo Kitchen & Bath Faucet Company